

FILE

# Union Special®

INDUSTRIAL SEWING MACHINES

PROPERTY OF  
DEVELOPMENT/CATALOG DEPT.

Please return to the Catalog Dept.

Date received to file: OCT 02 1992

**STYLE  
39500D**

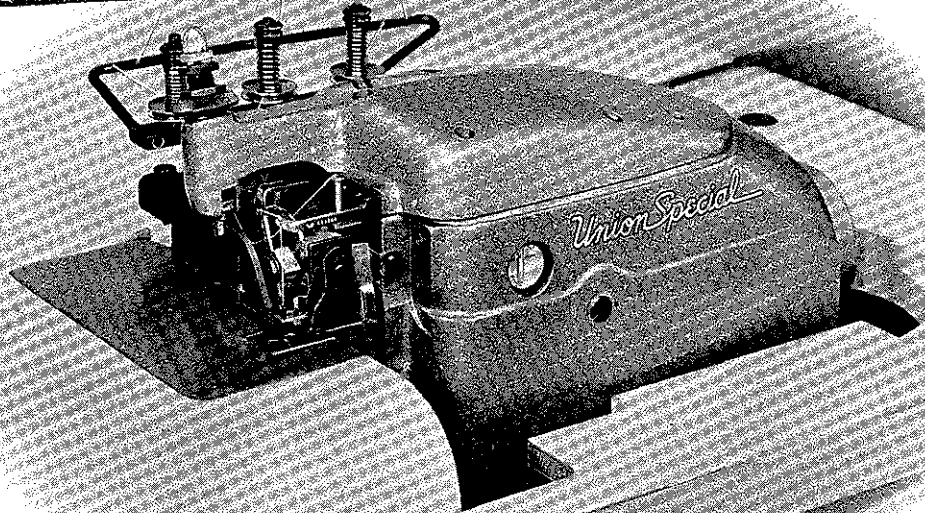

**CLASS 39500**

**CATALOG  
No.  
103D**

**STREAMLINED  
HIGH SPEED OVERSEAMERS**

*Union Special* **MACHINE COMPANY**  
CHICAGO

# INDUSTRIAL SEWING MACHINES

**... for Every Purpose!**

Job requirements vary — that's why Union Special builds a wide variety of specially designed sewing machines. It is also the reason why Union Special field representatives make a careful study of requirements before giving you detailed recommendations on the kind of equipment to install. Plants equipped with modern, high speed Union Specials have an important advantage. Union Special machines are built to do the job faster . . . better . . . cheaper, and they stay on the job with minimum time out for repairs. You're ahead when you use Union Special.

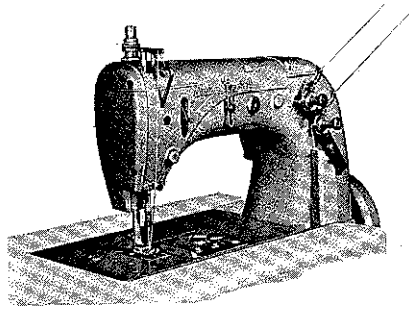

## 50000 SERIES MACHINES

The thousands of manufacturers using Union Special's new 50000 SERIES machines are finding these ultra-modern, streamlined models to be invaluable aids in cutting costs of operations and boosting production of a wide variety of products. Each of the many machines in the improved 50000 SERIES is specially designed to do a specific job efficiently, quickly, and economically!

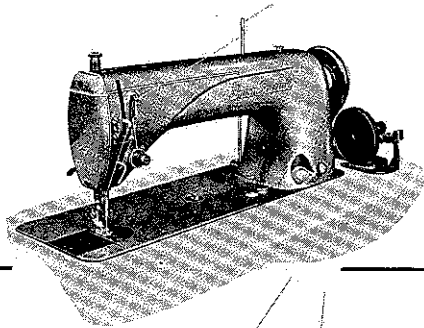

## THE 61400 LOCKSTITCH

Never before has a general purpose Lockstitch machine been so thoroughly engineered for handling modern industrial sewing requirements! And never has a machine offered more than the new Union Special SIXTY-ONE-FOUR — a superior machine for light or heavy weight work . . . for short runs as well as long . . . for tacking and back stitching . . . for curved seams and straight runs.

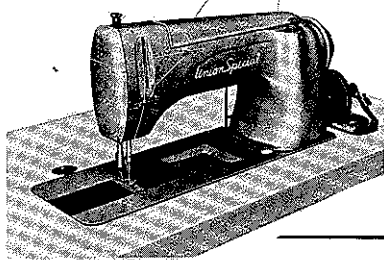

## NEEDLE FEED LOCKSTITCH MACHINES

Latest improvements in engineering, manufacturing methods, and materials have been combined in Union Special Class 61800 and Class 62200 needle feed Lockstitch machines providing operators with smooth, streamlined, light-running machines that reduce fatigue and strain. It's no wonder that manufacturers in plants throughout the country are praising the superior performance of these ultra-modern machines!

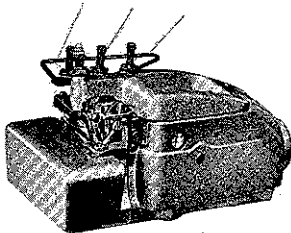

## THE NEW CLASS 39500 OVEREDGER

This new development antiquates every machine presently on the market for use where a curved needle machine is recommended. From its handsome, dynamically functional, modern design to its innermost mechanism, the THIRTY-NINE-FIVE has been produced to accelerate quicker . . . run faster . . . operate more smoothly and quietly . . . with less maintenance . . . and yield a greater profit than any other like equipment available to users today.

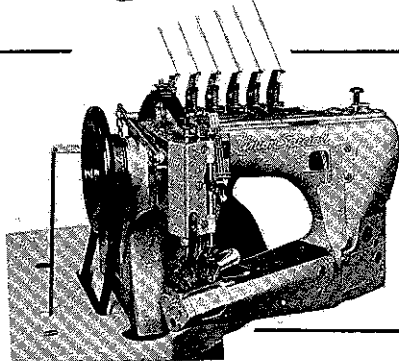

## 35700-35800 FEED-OFF-THE-ARM MACHINES

Union Special's popular feed-off-the-arm felling machines are light running, smooth operating machines that offer great advantages: sewing head of the latest type, new presser bar which practically eliminates feed marking, and presser foot which will lift at the lightest touch. Faster felling is certain with Union Special Class 35700-35800 feed-off-the-arm machines.

Catalog No. 103 D  
(Supplement to 103 S)

INSTRUCTIONS  
FOR  
ADJUSTING AND OPERATING  
LIST OF PARTS

CLASS 39500

Style  
39500 D

The parts listed in this catalog are  
furnished at list prices for repairs only.

First Edition

Copyright 1959  
by  
Union Special Machine Co.  
Rights Reserved in All Countries

*Union Special*  
**MACHINE COMPANY**  
INDUSTRIAL SEWING MACHINES  
**CHICAGO**

Printed in U.S.A.

## FOREWORD

The Class 39500 machine is Union Special's latest overedger. New streamlined styling, automatic lubrication, and light running high speed performance are characteristics of these machines. All parts are made by precision methods insuring complete interchangeability.

It is our constant aim to furnish carefully prepared information that will enable the customer to secure all possible advantages from the use of Union Specials. The following pages contain valuable operating and adjusting data, and illustrate and describe the parts for Styles in Class 39500.

Union Special representatives will be found in all manufacturing centers, anxious to cooperate with you to plan and estimate requirements.

*Union Special* MACHINE COMPANY

Engineering Department

## IDENTIFICATION OF MACHINES

Each Union Special machine is identified by a Style number which is stamped into the name plate.

Machines similar in construction are designated by a Class number which contains no letters. Letters suffixed to the Class number indicate the individual Standard machine style. Letter "Z", however, is reserved as a suffix to the Standard style identification to specify machine is of Special construction.

## APPLICATION OF CATALOG

This is a supplement to Catalog No. 103 S and should be used in conjunction therewith. Only parts found on Style 39500 D, but not on 39500 A, 39500 B or 39500 P, are illustrated. Opposite the illustration is listed the part name, number and quantity, by itemized detail numbers.

This catalog applies specifically to the Standard style of machine as listed herein. It can also be applied with discretion to some Special machines in this Class. References to direction such as right, left, front, back, etc., are given from the operator's position while seated at the machine.

## STYLE OF MACHINE

Single Curved Needle, Low Throw, Two Looper, Three Thread, Overseaming Machine, Differential Feed, Trimming Mechanism With Spring Pressed Lower Knife, Automatic Lubricating System.

39500 D For general purpose seaming of "T" shirts, polo shirts, panties, slips, etc., knee controlled stitch shortening mechanism to minimize possibility of ravelling, standard width of seam 1/8 inch. Seam Spec. 504-SSa-1.

## OILING

CAUTION! Oil was drained from machine when shipped, so reservoir must be filled before beginning to operate. Oil capacity of Class 39500 is six ounces. A straight mineral oil of a Saybolt viscosity of 200 to 250 seconds at 100° Fahrenheit should be used.

Machine is filled with oil at spring cap in top cover. Oil level is checked at sight gauge on front of machine. Red bulb on oil level indicator should show between gauge lines.

Machine is automatically lubricated. No oiling is necessary, other than keeping main reservoir filled. Check oil daily before the morning start; add oil as required.

Drain plug screw is located at back of machine near bottom edge of base. It is a magnetic screw designed to accumulate possible foreign materials which may have entered the crank case. It should be removed and cleaned periodically.

## IDENTIFYING PARTS

Where construction permits, each Union Special part is stamped with its catalog number. A part too small for its complete catalog stamping is identified by a letter symbol which distinguishes it from another part similar in appearance.

Each part number represents the same part regardless of catalog in which it appears.

**IMPORTANT! ON ALL ORDERS, PLEASE INCLUDE PART NAME AND STYLE OF MACHINE FOR WHICH PART IS ORDERED.**

## TERMS

Prices are strictly net cash and are subject to change without notice. All shipments are forwarded at the buyer's risk f.o.b. shipping point. Parcel Post shipments are insured unless otherwise directed. A charge is made to cover the postage and insurance.

## NEEDLES

Each Union Special needle has both a type number and a size number. The type number denotes the kind of a shank, point, length, groove, finish, and other details. The size number, stamped on the needle shank, denotes the largest diameter of the blade measured in thousandths of an inch midway between the shank and the eye. Collectively, type number and size number represent the complete symbol.

Selection of proper needle size should be determined by the size of the thread used. Thread should pass freely through the needle eye in order to produce a good stitch formation.

For best results, use only genuine Union Special needles in the operation of this machine. They are packaged under our brand name, *Union Special* which is backed by a reputation for producing highest quality needles for more than three-quarters of a century.

Style 39500 D uses curved blade needles. The standard needle for this style is Type 154GAS. It is a curved blade, standard length, single groove, shallow spot, long tapered point, struck groove, chromium plated in sizes 022, 025, 027, 029, 032, 036, 040, 044.

To have needle orders promptly and accurately filled, an empty package, a sample needle, or the type and size number should be forwarded. Use description on label. A complete order would read: "1000 Needles, Type 154GAS, Size 027".

## CHANGING NEEDLES, ETC.

All instructions with regards to Changing Needles, Thread Stand, Threading are the same as for Style 39500 B covered in Catalog 103 S.

## ASSEMBLING AND ADJUSTING SEWING PARTS

All instructions pertaining to the adjustment of Style 39500 D are same as those for Style 39500 B (described in Catalog 103 S) except for the following: (Changes are underlined).

1. Under heading "SETTING THE NEEDLE", (Page 8, Catalog 103 S):  
With the throat plate attached to the throat plate support (39580 C) and resting on the throat plate support bracket (39580 AB), needle should center in the front end of needle slot.
2. **SETTING THE LIFTER LEVER STOP**  
(New to Style 39500 D)

Simulated tacking is obtained by increasing the number of stitches per inch sewn at the start or finish of a garment. The number of stitches per inch is increased by raising the throat plate which in effect reduces the effective feed dog travel.

While sewing on material, adjust the lifter lever stop (A, Fig. 1) so that when the knee press is engaged, the lifter lever (B) raises the throat plate to a height required to obtain the desired increase in the number of stitches per inch sewn. Screw (C) is used to secure the lifter lever stop.

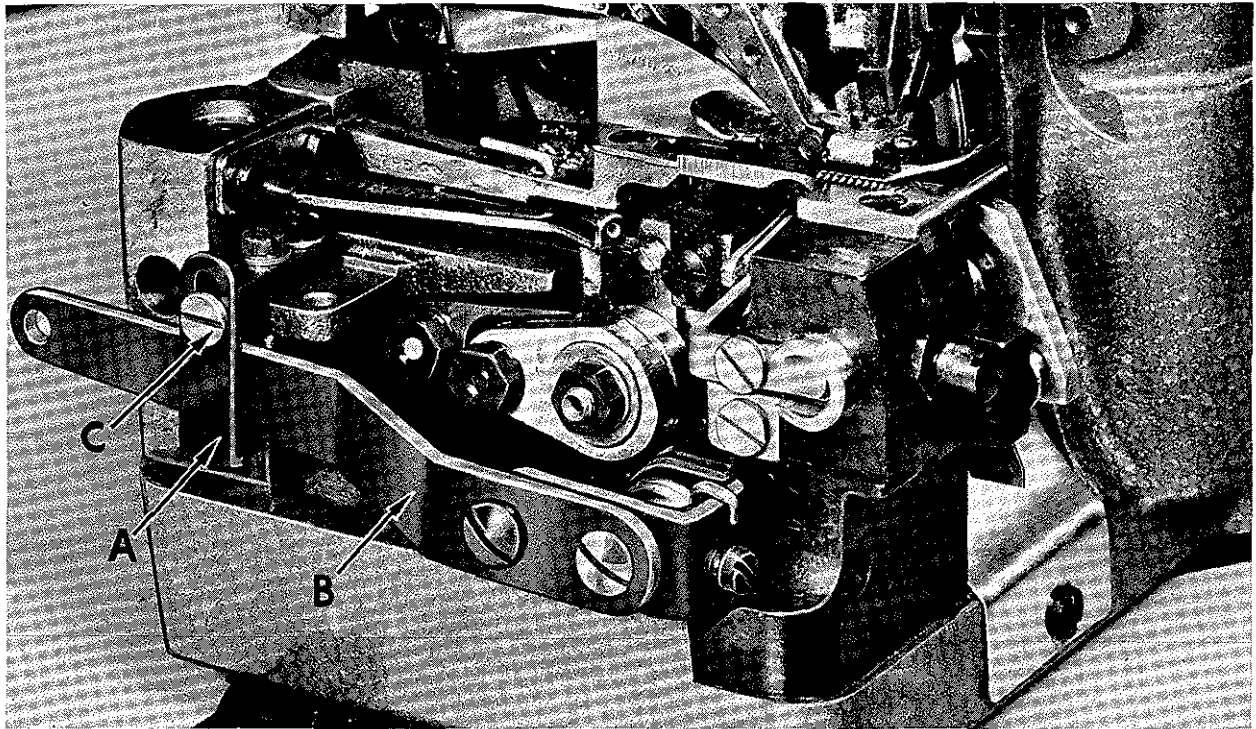
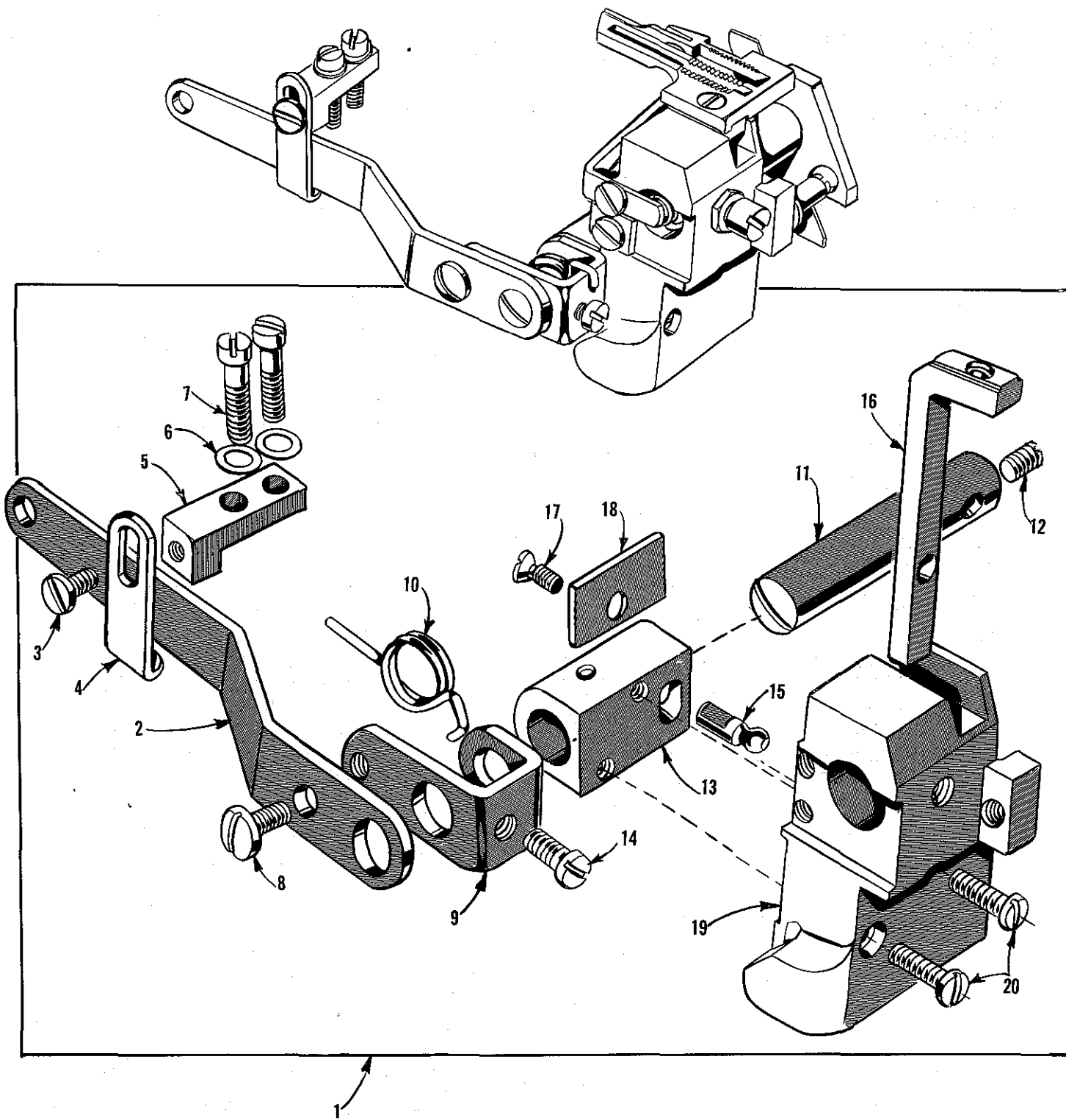

Fig. 1

NOTE: The stitch shortening mechanism can be purchased complete under No. 29480 CC and can be applied to all Styles in Class 39500 except hemming machines and those equipped with intermittent differential feed.





The parts illustrated on the preceding page and described below represent parts used on Style 39500 D; but are not used on Style 39500 B.

Parts shown in phantom view and bearing no reference numbers are common to Styles 39500 D and 39500 B.

Use Catalog 103 S for all parts and instructions applicable to 39500 B not illustrated or described here.

<u>Ref. No.</u>	<u>Part No.</u>	<u>Description</u>	<u>Amt. Req.</u>
1	29480 CC	Stitch Shortening Mechanism, complete -----	1
2	39581	Throat Plate Lifter Lever -----	1
3	22585 C	Screw -----	1
4	39581 F	Lifter Lever Stop -----	1
5	39581 G	Lifter Lever Stop Block -----	1
6	53634 C	Feed Bar Guide Washer -----	2
7	22541	Screw, for lifter lever stop block -----	2
8	22570 A	Screw, for throat plate lifter lever -----	1
9	39581 A	Lifter Lever Clamp -----	1
10	39581 B	Lifter Lever Clamp Spring -----	1
11	39581 C	Lifter Lever Shaft -----	1
12	89	Screw -----	1
13	39581 E	Lifter Lever Bearing Block -----	1
14	22596 D	Screw, for lifter lever clamp -----	1
15	39581 D	Lifter Lever Shaft Stud -----	1
16	39580 C	Throat Plate Support -----	1
17	22524	Screw, for throat plate retaining plate -----	1
18	39580 D	Throat Plate Retaining Plate -----	1
19	39580 AB	Throat Plate Support Bracket -----	1
20	22516 A	Screw, for lifter lever bearing block -----	2



# Union Special<sup>®</sup>

INDUSTRIAL SEWING MACHINES

## SALES OFFICES AND REPRESENTATIVES

### UNITED STATES

ALLEN TOWN, PA., P.O. Box 542, L. D. Cassell, Tel. Hemlock 4-3900.

★ATLANTA 3, GA., 81 Peachtree Pl., N.W., P.O. Box 7005, Station C, W. G. Booth, Mgr. Tel. Trinity 4-2733.

BALTIMORE 15, MD., P.O. Box 2505, R. B. Foster, Tel. Sar. 7-8499.

BIRMINGHAM, ALABAMA, 8630 First Ave. South, L. D. Baldwin, Tel. Vernon 3-9904.

★BOSTON 11, MASS., 179 Lincoln St., Wm. E. Palm, Mgr., Tel. Liberty 2-0147.

CANTON, MASS., York St., RFD, R. T. Pedersen, Tel. Canton 6-1412.

★CHICAGO 10, ILL., 404 N. Franklin St., O. A. Ulrick, Mgr., Tel. Superior 7-6920.

★CINCINNATI 25, OHIO, 3372 Central Pkwy., A. E. Brauch, Mgr., Tel. Kirby 1-5558.

CLEVELAND 3, OHIO, 6801 Euclid Ave., Rm. 2, W. D. Speer, Tel. Henderson 2-1714.

COLUMBIA, S. C., 103 South Queen Rd., V. R. Crisler, Tel. Alpine 4-1351.

COMMERCE, GA., Lakeview Drive, J. T. Hanley, Tel. Federal 5-4061.

★DALLAS 19, TEXAS, 4200 Hines Blvd., P.O. Box 6727, Z. X. Bennett, Mgr., Tel. Lakeside 6-8369.

DANBURY, CONN., Kenosia Ave., Lakeview Park, R. W. Gaines, Tel. Pioneer 8-9333.

DECATUR, GA., 802 Derrydown Way, J. V. Parker, Tel. Drake 7-5559.

DENVER 10, COLO., 1801 South Marion St., L. E. Carter, Tel. Spruce 7-7060.

DETROIT 35, MICH., 16630 Ward Ave., J. F. Lux, Tel. University 3-4948.

DUBLIN, GA., 1512 Highland Ave., J. W. Jones, Tel. Broadway 2-4663.

GREENSBORO, N. C., P.O. Box 226, W. D. Harrod, Tel. Broadway 3-7648.

GREENVILLE, S. C., 25 Sir Abbot St., O. W. Gregory, Tel. Cedar 9-5539.

(HAZELTON) CONYNGHAM, PA., P.O. Box 46, R. S. Vogt, Tel. Sunset 8-5556.

JACKSON 3, MISS., 327 Eastview St., J. A. Bayette, Tel. Fleetwood 5-1976.

JOHNSON CITY, N. Y., 471 Main St., J. J. Lafter, Tel. Johnson City 7-3994.

KANSAS CITY, KAN., 1621 N. 46th St., D. I. McFarland, Tel. Mayfair 1-3325.

KANSAS CITY 34, MO., 10904 Grandview Road, T. O. Biggers, Tel. South 1-5030.

KNOXVILLE 19, TENN., 400 Bellemeade Ave., N.W., H. E. Clinard, Tel. 8-1865.

LEBANON, PA., P.O. Box 274, D. M. Bender, Tel. Crestview 2-6292.

★LOS ANGELES 15, CALIF., 119 E. Pico Blvd., P. M. Mason, Mgr., Tel. Richmond 7-9187.

LOUISVILLE 18, KY., 3122 McMahan Blvd., B. L. Rogers, Tel. Glendale 4-4956.

LYNCHBURG, VA., P.O. Box 1075, C. D. Mairs, Tel. Victor 6-1215.

LYNDHURST, N. J., 339 Harding Ave., C. A. Wheeler, Tel. Webster 9-4143.

MEMPHIS 17, TENN., 4695 Dunn Rd., R. J. Lindhorst, Tel. Mutual 5-6750.

MIAMI 37, FLA., 2101 Northwest 1st Ave., H. L. Simon, Tel. Franklin 1-0323.

MINNEAPOLIS, MINN., 2800 Texas Ave., St. Louis Park, Minn., L. W. Koehler, Tel. Midway 4-6236.

MONTGOMERY 7, ALA., 1959 Amelia Drive, G. H. Hamlet, Tel. Amherst 5-0942.

NASHUA, N. H., 21 Alder Dr., Forest Pk., H. Haberman Jr., Tel. Tuxedo 2-9698.

NASHVILLE 12, TENN., 1602 South Observatory Drive, W. J. Brauch, Tel. Cypress 2-5123.

NEW ORLEANS, LA., P.O. Box 1065, Chalmette, La., L. A. Van Hooser, Tel. Edgewood 1-3106.

★NEW YORK 16, N. Y., 116 E. 27th St., C. L. Rosenquist, Mgr., Tel. Murray Hill 9-1266. Export Office, 405 Lexington Ave., Room 3200, H. P. Johnson, Mgr., Tel. Oxford 7-5476. Lewis-Columbia Machines, 315 W. 35th St., Ben Zahler, Mgr., Tel. Chickering 4-8800.

OKLAHOMA CITY 19, OKLA., 2226 Southwest 53rd St., G. B. Wiley, Tel. Mutual 5-2836.

★PHILADELPHIA 24, PA., 4234-42 Macalester Ave., B. W. Merz, Mgr., Tel. Gladstone 5-9800.

PITTSBURGH 26, PA., 521 Brookline Blvd., R. H. Marsh, Tel. Locust 3-3589.

PLANT CITY, FLA., 214 N. Gordon St., J. C. Morgan, Tel. 3-2681.

RIVERTON, N. J., P.O. Box 6, E. W. White, Jr., Tel. Talmadge 9-3508.

RUTHERFORD, N. J., 246 Sylvan St., R. W. Whitson, Tel. Geneva 8-2178.

ST. LOUIS 21, MO., 9860 Guthrie Ave., C. E. McLaughlin, Tel. Chestnut 1-2368. 5783A McPherson Ave., J. R. McConnell.

SALT LAKE CITY, UTAH, 1215 E. 13th South St., L. F. Rosvall.

SAN ANTONIO 6, TEXAS, C. C. Smith, P.O. Box 201, Tel. Diamond 4-1158.

SAN FRANCISCO 7, CALIF., 1275 Mission St., R. J. Vail, Tel. Underhill 1-1580.

SEATTLE, WASH., 808 Motor Pl. P. D. Lockett, Tel. Main 4-8083.

TAUNTON, MASS., P.O. Box 141, Raynham, W. P. Godek, Tel. VanDyke 2-6149.

(TROY) LATHAM, NEW YORK, 19 Aragon Ave., J. R. LeTourneur, Tel. State 5-6663.

WORCESTER, MASS., 11 Woodside Dr., Grafton, A. M. Buckley, Tel. Vernon 9-3340.

YORK, PA., P.O. Box 884, R. L. Smith, Tel. York 34-191.

### CANADA

Union Special Machine Co. of Canada, Ltd.

BOWNESS, ALBERTA, P.O. Box 372, N. W. Holt, Tel. 886796.

MONTREAL 14, QUEBEC, C. F. Amey, Mgr., 40 Moliere St., Tel. Crescent 6-2575.

NORTH VANCOUVER, B. C., J. Stewart, 118 E. Esplanade St.

QUEBEC, QUEBEC, I. A. Bouchard, 29 Avenue Renaud, Tel. MA 3-1939.

★TORONTO 28, ONTARIO, S. J. Storey, Managing Director, 355 King St. West, Tel. Empire 6-2939.

WINNIPEG, MANITOBA, F. Thierman, Rm. 201, Whitehall Bldg., 70 Arthur St., Tel. Whitehall 3-4933.

## SALES AGENTS FOR LEWIS MACHINES

### UNITED STATES

ATLANTA, GA.—Cutters Exchange of Georgia, Inc., 338 Peachtree St., N.E., Tel. Jackson 4-2836.

BALTIMORE 1, MD.—J. Dashew, Inc., 417 W. Baltimore St., Tel. Lexington 9-1838.

BOSTON 11, MASS.—Industrial Sewing Machine & Supply Corp., 74 Harrison St., Tel. Liberty 2-7000.

CHICAGO 7, ILL.—L. M. Stein Co., 815 W. Van Buren St., Tel. Central 6-6980.

CLEVELAND 3, OHIO—Sydney I. Hirsch Co., 6020 Euclid Ave., Tel. Express 1-8811.

DALLAS 2, TEXAS—Dallas Sewing Machine Co., 611 Main St., Tel. Ri. 7-2491.

DETROIT 7, MICH.—M. J. Foley Co., 6402 E. Jefferson Ave., Tel. Lorain 8-0900.

FALL RIVER, MASS.—Industrial Sewing Machine & Supply Corp., 101 Bank St., Tel. Osborn 8-8383.

KANSAS CITY 5, MO.—Textile Machinery Co., 324 W. 9th St., Tel.

MIAMI 37, FLA.—H. L. Simon & Co., 2101 N. W. First Ave., Tel. 82-0323.

NASHVILLE 3, TENN.—Cutters Exchange, Inc., 901 Demonbreun St., Tel. Alpine 5-5661.

NEW ORLEANS 16, LA.—Konas Mfg. & Sewing Machine Co., 531-33 Decatur St., Tel. Magnolia 5482.

NEW YORK 1, N. Y.—Union Special Machine Company, 315 W. 35th St., Tel. Chickering 4-8800.

PHILADELPHIA 7, PA.—S. Bolder & Co., Inc., 129 12th St., Tel. Walnut 3-1080.

PORTLAND, ORE.—Golden Sewing Machine Co., 2402 S.E. Belmont, Tel. Empire 0575.

ROCHESTER 9, N. Y.—A. J. Adams Co., 1051 Culver Rd., Tel. Culver 3314 J.

SAN ANTONIO 7, TEX.—Alamo Sewing Machine Co., 1412 W. Commerce, Tel. CA 7-6328.

SAN FRANCISCO 3, CAL.—Apparel City Sewing Machine Co., 1155 Mission St., Tel. Market 1-6660.

SEATTLE 1, WASH.—Campbell Sewing Machine Co., 2314 4th Ave., Tel. Main 3-5163.

### CANADA

MONTREAL, QUEBEC—John Garde & Co., Ltd., 3702 S. Lawrence Blvd., Tel. Plateau 1766.

TORONTO, ONTARIO—John Garde & Co., Ltd., 391 Spadina Ave., Tel. Walnut 3-7379.

WINNIPEG, MANITOBA—Rubenstein Bros. (Western) Ltd., 324 Main St., Tel. 93-5526.

# SALES AGENTS FOR UNION SPECIAL MACHINES

Also Agent for (L) LEWIS and  
(C) COLUMBIA where marked.

## AFRICA

**BELGIAN CONGO, ELIZABETHVILLE**—Electrofrig (sub-agent Berzack Bros. Ltd., Johannesburg, Union of South Africa.)  
**MAURITIUS, PORT LOUIS**—(Bag Closing & Bag Making Machines) Hall, Geneva, Langlois, Ltd., 42 Sir William Newton St., P.O. Box 77.  
**MOROCCO, CASABLANCA**—R. Geissmann & Fils, Rue du Soldat Sanchez. (L)  
**SOUTHERN RHODESIA, FEDERATION OF RHODESIA & NYASALAND, BULAWAYO**—(Textile Machines) Berzack Bros. Ltd., 16-14th Ave.  
**SALISBURY**—(Bag Closing Machines) South African Sale Co., Pty., Ltd., Forbes & Angwa Sts.  
**TUNISIA, TUNIS**—Comptoir Industriel & Menager, 8 Rue de Provence. (L)  
**UNION OF SOUTH AFRICA, JOHANNESBURG**—(Textile Machines) Berzack Bros., Ltd., Berbro House, 135/7 Pritchard St. Branches at CAPETOWN—78 Darling St.; DURBAN—72-74 Commercial Road; PORT ELIZABETH—58 Queen St.  
**JOHANNESBURG**—(Bag Closing Machines) South African Sale Co., Pty., Ltd., 32 Van Brandis St. Branches at: BLOMFONTEIN—53 Zastron St.; CAPETOWN—Wales & Bree Sts.; DURBAN—22 Allival St.; EAST LONDON—38 Argyle St.; PORT ELIZABETH—Box 611. Also at PIETERMARITZBURG, PRETORIA, VEREENIGING and WORCESTER.

## AUSTRALIA

Sole Distributor—Capron, Carter (Pty.) Ltd.  
**NEW SOUTH WALES, SYDNEY**—86 Liverpool St. (L)  
**QUEENSLAND, BRISBANE**—Rm. 55, Rex Bldg., Wickham St., Valley.  
**SOUTH AUSTRALIA, ADELAIDE**—(Sub-agents) Topp & Farmer, Ltd., 177 Hindley St.  
**TASMANIA, HOBART**—(Sub-agents) Reliance Trading Co., 105 MacQuarie St.  
**VICTORIA, MELBOURNE**—78 A'Beckett St.  
**WEST AUSTRALIA, PERTH**—(Sub-agents) Thomsons, Ltd., 789 Hay St.

## ASIA

**CAMBODIA, PHOM-PENH**—Denis Freres, P.O. Box 48. C & L  
**HONGKONG**—G. R. Coleman Co. (Hongkong) Ltd., Room 308, Bank of Canton Bldg., 6 Des Voeux St., Central. (L)  
**INDIA, CALCUTTA**—Don, Watson & Co., Ltd., 19 British Indian St. (L)  
**JAPAN, OSAKA**—Mima Sewing Machine Mfg. Co., 29, 1-chome, Ebi-Kami, Fukushima-ku. Branch at 76 Take-machi, Taiko-Ku, Tokyo-To.  
**KOREA, SEOUL**—Uebersee-Handel A.G., Rm. 604, Bando Bldg., 180 1-Ka Ulchiro; Chung-Ku Int. P.O. Box 1268. (L)  
**LAOS, VIENTIANE**—Denis Freres, P.O. Box 133. (C & L)  
**TAIWAN, TAIPEI**—G. R. Coleman Co. (Hongkong) Ltd., 16 Nan Yana St. (L)  
**VIETNAM, SAIGON**—Societe des Riz d'Indochine, Denis Freres, P.O. Box 444, 4 Rue Tu Do. (C & L)

## BRITISH WEST INDIES

Union Special International, Inc.

**JAMAICA, KINGSTON**—M. E. Parkin, 102 King St. (L)

## EUROPE

**AUSTRIA, VIENNA**—Firma Nahschuster, Mariahilferstr. 51.  
**BELGIUM, BRUSSELS**—Union Special Machine Corporation of America, 23 Rue Philippe de Champagne, Henri De-laof, Mgr.  
**BRITISH ISLES**—(Bag Closing and Bag Making Machines) Thomas C. Keay, Ltd., 15 Baltic St., Dundee, Scotland.  
**DENMARK, COPENHAGEN**—Rothenborg Specia.maskiner for Sy-industrien A/S, Nikolaj Plads 23. Offices at: HERNING, KOLDING, ODENSE, RISSKOV-AARHUS, SILKEBOEG. (L)  
**EIRE, DUBLIN**—(Textile Machines) Machines, Ltd., 24 Upper Abbey St. (C) (Bag Closing and Bag Making Machines) Thomas C. Keay, Ltd., 15 Baltic St., Dundee, Scotland.  
**ENGLAND**—(Textile Machines)—LEICESTER, Union Special Machine Co. Ltd., 25 Bede Street, Braunstone Gate, A. B. Fitzpatrick, Mgr. LONDON, E.C. 1, Union Special Machine Co., Ltd., 15-17 City Road, G. Johnson & Son (Sewing Machine Mfg. Ltd.) 53 Great Titchfield St. London W.1. NOTTINGHAM, W. Wilkes, 24 Plantation Road, Wollaton MANCHESTER, J. S. A. Smith (Manchester) Ltd., 3 Oxford Road, PORTSMOUTH, The Saunders Machine Co. (Portsmouth) Ltd., 206 London Rd.  
**FINLAND, HELSINKI-LAUTTASAARI**—Suomen Konelike O/Y, Vattunienkatu 13. TURKU (L & C), Tmi Helkama, Sub Agent, Yliopistonkatu 16.  
**FRANCE, PARIS**—Cle. des Machines Union Special de France, 91 Ave. de la Republique, Georges Linotte, Mgr. Bargets, S.A., 8 Rue des Francs-Bourgeois.  
**GERMANY, STUTTGART**—Union Special Maschinenfabrik, G.m.b.H., Schwabstrasse 33, A. W. Krieger, Managing Director. BIELEFELD BRANCH, Bielefeld, Detmolder Str. 244. EBINGEN BRANCH, Ebingen/Württ., Gartenstr. 44. FRANKFURT BRANCH, Frankfurt - Main - Rodelheim, Reichsburgstr. 8. HAAMBURG BRANCH, Hamburg-Eimsbützel, Lappenbergsalle 4d. KOLN BRANCH, Koln am Rhein, Auf dem Hünenrücken 25. MÜNCHEN BRANCH, Grund/Tagernsee, Bernocksiedlung 7.  
**GREECE, ATHENS**—Michel D. Dimoulis & 30 Petraki St.  
**ITALY, MILANO**—Giovanni Conti & Nipoli, Piazzale Marengo 6. (L)  
**THE NETHERLANDS, AMSTERDAM**—N. V. Machinehandel C. & H. Verbeek, Kloveniersburgwal 77. Offices at: GRONINGEN, ENSCHEDE, ROTTERDAM, SITTARD. (L)  
**NORTHERN IRELAND, BELFAST**—(Textile Machines) W. & J. Bogod & Co., Ltd., 6 Linenhall St. (C)  
**NORWAY, OSLO**—Jac. Jacobsen A/S, Kr. Augustsgate 19 (Tullingsgarden). BERGEN—Bjornsonst 24. (C)  
**PORTUGAL, PORTO**—Rost & Janus, Succs. Lda., Rua Barao de Forreter 914.  
**SCOTLAND, DUNDEE**—Thos. C. Keay, Ltd., 15 Baltic St. (Bag Closing and Bag Making Machines).  
**SCOTLAND, GLASGOW, S.E.**—(Textile Machines) Allardice & Co., Stevenson St.  
**SPAIN, BARCELONA**—Rapida, S.A., Avino 9. (L)  
**SWEDEN, BORAS**—Rud. Nyström & Co., A/B, Lilla Bran-nerigatan 6. Branches at OREBRO-Ostra Banagan 18. MALMO, S. Forstadsatan 16. Sub-Agent STOCKHOLM, A/B Forsberg & Kato, Tomtebodatan 38.  
**SWITZERLAND, ZURICH**—M. L. Bourquin, Albisrieder-strasse 226.

## LATIN AMERICA

Union Special International, Inc.

**ARGENTINA, BUENOS AIRES**—Kay, Grandjean & Cia., Bartolome Mitre 760. (L)  
**BRAZIL, SAO PAULO**—Maquinas de Costura Industriais Panambra, S.A., Rua Aurora 59A-71. (C) Branches at PORTO ALEGRE—Rua Voluntarios da Patria 533; RECIFE—Rua Princesa Isabel 105; RIO DE JANEIRO—Rua Alexandre MacKenzie 117.

**CHILE, SANTIAGO**—Lowenstein & Stewart, S.A.C., Calle Santa Domingo 1140. (L)  
**COLOMBIA, BOGOTA**—Mactalzade, Ltda., Calle 13 #22-53. Branches at CALI—Carrera 7a#14-33/35, MEDELLIN—Carrera 51, (Bolivar) #41-180. (L)  
**COSTA RICA, SAN JOSE**—Champion Co., Ltda., Apartado 2742.  
**CUBA, HAVANA**—(Textile & Bag Making Machines) An-tilla Yarn & Supply Co., S. A., Factoria 70. (L) (Bag Closing Machines) Miguel A. Vilato, Edificio Martinez y Vilato, Via Blanca Rd.; GUANABACOA, HAVANA—Apartado 644.  
**DOMINICAN REPUBLIC, CIUDAD TRUJILLO**—Luis Dominguez, S., Calle 19 de Marzo #25. (L)  
**ECUADOR, QUAYAQUIL**—Richard O. Custer, S.A., 9 de Octubre 211-213. Branch at QUITO—Carrera Benalzar 669.  
**EL SALVADOR, SAN SALVADOR**—Vairo Hermanos, Colonia Yairo.  
**GUATEMALA, GUATEMALA**—Compania Argo-Comercial, S.A., 8a Avenida Sur #10-43.  
**MEXICO, MONTERREY, N.L.**—Talleres Perez Zozaya, S.A., Cuauhtemoc Norte 335. Branches at: GUADALAJARA, JAL.—Hidalgo 45 y 47; MEXICO, D.F.—Perez Zaragoza S.A., Regina 26; SAN LUIS POTOSI, S.L.P.—J. de los Roves 80. (L)  
**NICARAGUA, MANAGUA**—Casa Hentgen, 1a Ave. S.E. #401. (L)  
**PERU, LIMA**—A. y F. Wiese, S.A., Esq. Nunez y Filipinas. (L)  
**PUERTO RICO, SAN JUAN**—Abarca Warehouses Corp., P.O. Box 2352.  
**URUGUAY, MONTEVIDEO**—Carlos Dighiero e Hijos, Calle Convencion 1424. (L)  
**VENEZUELA, CARACAS**—H. Blohm, S.A., Dr. Paul A. Chorro 29. (L)

## NEAR EAST

**EGYPT, CAIRO**—A. Kavaldjian, 4 Midan el Cheikh Barakat. (L)  
**IRAN, TEHERAN**—Sava Trading Corp., Ave. Bazarjomehri 655.  
**IRAQ, BAGHDAD**—Sons of O. O. Agopian, P. O. Box 121.  
**ISRAEL, TEL AVIV**—L. Taube, Ltd., 15 Lilienblom St. (L)  
**LEBANON, BEIRUT**—Sons of O. O. Agopian, P.O. Box 1765.  
**SYRIA, DAMAS**—Elias Aractingi & Fils, Sidi Amoud.  
**TURKEY, ISTANBUL**—David ve Leon Varber ve Seriki, Hamdi Bey Gecidi 36, 38, 40, Posta Kutusu 385.

## NEW ZEALAND

Sole Distributor—H. A. Tuck & Co., Ltd.  
**AUCKLAND**—171 Albert St. (L)  
**CHRISTCHURCH**—(Sub-agent) Glendermid, Ltd., 78 Lichfield St.  
**DUNEDIN**—(Sub-agent) Glendermid, Ltd., 18 Dowling St. (C)  
**WELLINGTON**—Ford Bldg., Courtenay Place.

## PACIFIC ISLANDS

**HAWAII, HONOLULU** 13—Territorial Sales Co., 1177 Bishop St. (L)  
**HAWAII, HONOLULU**—(Bag Closing and Bag Making Machines) H. S. Gray Co., 759 Puulua Rd.  
**PHILIPPINE ISLANDS, MANILA**—(Textile Machines) Atkins, Kroll & Co., Inc., 124 Myers Bldg., Port Area. Branch at CEBU, (L) (Bag Closing and Bag Making Machines) Earnshaws Docks & Honolulu Iron Works Co., Tacoma & 2nd Sts., Port Area.

# SALES AGENTS FOR LEWIS AND COLUMBIA MACHINES

(L) LEWIS; (C) COLUMBIA.

**ARGENTINA, BUENOS AIRES**—Moises Zazulle, S.R.L., Sarmiento 2725. (L)  
**AUSTRALIA, MELBOURNE**—Michaelis, Hallenstein & Co., Pty., Ltd., 441 Lansdale Street. (C)  
**AUSTRIA, VIENNA**—Herman Kemm, VIII Schloßelgasse 17. (L)  
**AUSTRIA, FELDKIRCH/VORALBERG**—Magnus Malin, P.O. Box 40. (L)  
**AUSTRIA, VIENNA XVII**—Franz Karpert, Wahringerstrasse 141. (C)  
**BELGIUM, BRUSSELS**—N. V. Machinehandel C & H Verbeek, 57A Blvd. du Jardin Botanique, Buyl Building. (L)  
**BELGIUM, BRUSSELS**—Etablissements Jacques S.A., 37 Rue de l'Avenir. (C)  
**BRAZIL, PORTO ALEGRE**—Casa de Maquinas Falk, Ltda., Caixa Postal 983. (L)  
**CHILE, SANTIAGO**—Distribuidora Kupfer Ltda., Libertad 46 (Casilla 10416). (C)  
**CUBA, HAVANA**—American Sewing Machine Co., Dragones 202. (C)  
**CUBA, HAVANA**—Caribbean Merchandising Co., Zulueta 617, Altos (P.O. Box 1066). (C)  
**DENMARK, COPENHAGEN**—Dimas, Det Internationale Industrimaskine A/S, Grønnegade 10. (C)  
**ENGLAND, LONDON**—The Eastman & Textile Machines Co., 15-17 City Road. (L)  
**FRANCE, PARIS**—Societe G. Arnon & Cie., 36 Rue Debel-leyne. (L)  
**FRANCE, PARIS**—Aspe-Dumont & Cie., 13 Rue de la Fontaine-Au-Roi. (C)  
**GERMANY, KREFELD**—Hergert Janssen, Alte Linner Strasse 104. (C)  
**INDIA, DELHI**—Munshi Ram B.Sc., Above Keventers, Kashmere Gate. (L)

**ISRAEL, TEL AVIV**—Israel Sewing Machine Co., 22 Yehuda Halevy St. (C)  
**ITALY, MILANO**—Societa Pfoff Italiana S.P.A., Via Martini 13. (C)  
**JAPAN, OSAKA**—Kanda Sewing Machine Co., 153 Umegae-cho, Kita-ku. (L)  
**JAPAN, TOKYO**—Iwase Sewing Machine Co., Ltd., 39, 1-chome, Kamezawa-cho, Sumida-Ku. (L)  
**MEXICO, MEXICO, D.F.**—Casa Diaz de Maquinas de Coser, Apartado Postal 7259. (C)  
**THE NETHERLANDS, DEN HAAG**—N. V. Reineveld Den Haag, P.O. Box 1036. (C)  
**NORWAY, OSLO**—J. A. Johansen A/S, Torvgatan 10. (L)  
**THE PHILIPPINES, MANILA**—J. B. Y. Tanlimco Sons, Inc., 455-457 Juan Luna. (C)  
**PUERTO RICO, SANTURCE**—Ed Mayfield Co., 1108-B Fernandez Juncos Ave., Stop 171/2, Box 9999. (L)  
**PUERTO RICO, SANTURCE**—Humberto A. Collado, Box 6777, Laiza Station. (C)  
**SWEDEN, BORAS**—Aktiebolaget A. G. Gustafson, Kungsgatan 28. (L)  
**SWEDEN, BORAS**—Husqvarna Industrismaskiner, Kungsgatan 34. (C)  
**SWITZERLAND, ZURICH**—Fritz Zellweger & Co., Selnaustrasse 27. (L)  
**SWITZERLAND, ZURICH**—A. Bunschwiler, Strassburgstrasse 15. (C)  
**TUNISIA, TUNIS**—Comptoir Industriel & Menager C.I.M., 8 Rue du 18 Janvier 1952. (L)  
**URUGUAY, MONTEVIDEO**—Compania Recons S.A. (Intercom Ltd.), Convencion 1374. (C)  
**WALES, CARDIFF**—W & J Bogod & Co., Ltd., Newport Road. (C)

# Aid Plant Layout! Boost Production!

## PEDESTAL MOUNTED MACHINES

UNION SPECIAL'S pedestal mountings for sewing heads have offered a great many advantages to manufacturers ever since they were introduced as a revolutionary new type of mounting for feed-off-the-arm machines in Classes 35700 and 35800.

In the pedestal mounted type installation, the machine is completely isolated from the base and, where table boards are used, they are completely isolated from the pedestal and from the machine, which makes for smoother, quieter operation. In various cases, the motor may be mounted to the right or to the left under the machine handwheel. Mounting of the motor to the right provides maximum space under machine for the operator.

These new pedestals offer maximum flexibility, convenience, and adaptability to production lines, especially where variations in operation or garment styles are necessary from time to time. The foot treadles are adjustable laterally and the machine mounting bracket is adjustable vertically to suit the individual operator and to provide the most comfortable working position, thus reducing fatigue. The illustrations shown here are just a few of the many styles of machines that Union Special has to offer in the pedestal mounted type installation which manufacturers all over the world have found to be necessary equipment for increasing production.

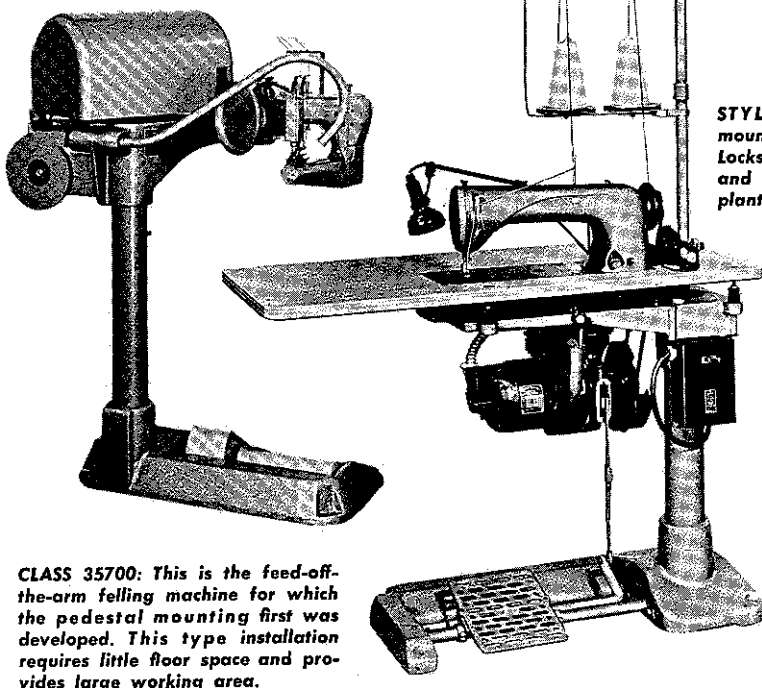

**CLASS 35700:** This is the feed-off-the-arm felling machine for which the pedestal mounting first was developed. This type installation requires little floor space and provides large working area.



**STYLE 52900 BH:** For simultaneously seaming and overedging the inseams and outseams of corduroy pants and similar articles.

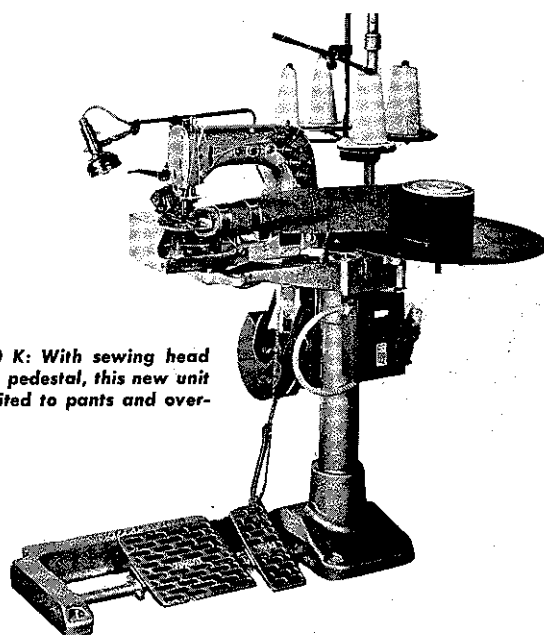

**STYLE 54200 K:** With sewing head overhanging pedestal, this new unit is ideally suited to pants and over-all banding.

**STYLE 61400 A:** The pedestal mounted, plain feed, single needle Lockstitch makes a most flexible and versatile unit for any sewing plant.

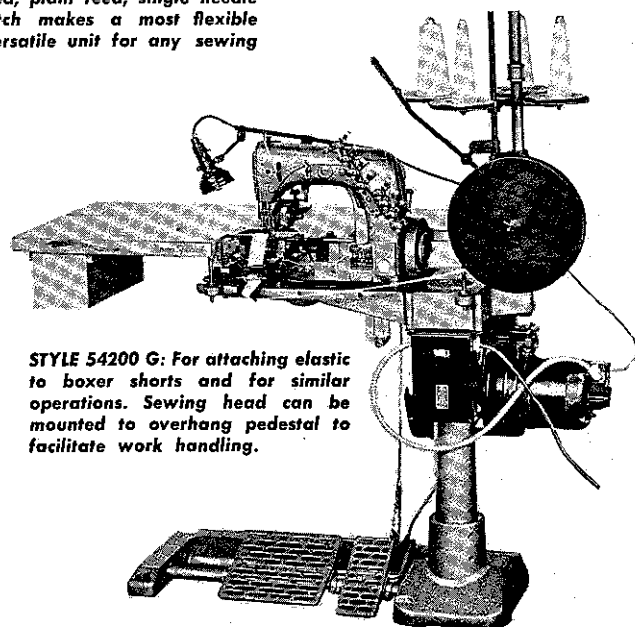

**STYLE 54200 G:** For attaching elastic to boxer shorts and for similar operations. Sewing head can be mounted to overhang pedestal to facilitate work handling.